



DIESEL GENERATOR SET

50 Hz

SERVICE		STAND BY	PRIME
Power	kVA	400	365
Power	kW	320	292
Speed	r.p.m	1500	
Standart Voltage	V	400/231	
Power Factor	Cos Phi	0,8	

Prime Power (PRP)

According to ISO 8528-1:2005, Prime power is the maximum power which a generating set is capable of delivering continuously whilst supplying a variable electrical load when operated for an unlimited number of hours per year under the agreed operating conditions with the maintenance intervals and procedures being carried out as prescribed by the manufacturer. The permissible average power output (Ppp) over 24 h of operation shall not exceed 70 % of the PRP.

Emergency Standby Power (ESP):

According to ISO 8528-1:2005, Emergency standby power is the maximum power available during a variable electrical power sequence, under the stated operating conditions, for which a generating set is capable of delivering in the event of a utility power outage or under test conditions for up to 200 h of operation per year with the maintenance intervals and procedures being carried out as prescribed by the manufacturers. The permissible average power output over 24 h of operation shall not exceed 70 % of the ESP.

ENGINE

SPECIFICATIONS

Brand		SDEC
Model		SC12E460D2
Power StanBDy	kW	338
Power Prime	kW	307
Cycle		4
Displacement	lt	11,8
Number Of Cylinders		6, in line
Bore and Stroke	mm	128 x 153
Compression Ratio		17:01
Governor		Electronic
Induction		Turbocharged-Intercooler
Cumbustion System		Direct
Cooling System		Water
Fuel Consumption %100 Load	lt/h	72
Fuel Consumption %75 Load	lt/h	53
Fuel Consumption %50 Load	lt/h	36
Total Lubrication System Capacitty	lt	41
Total Coolant Capacity	lt	80,2

ALTERNATOR

SPECIFICATIONS

Number Of Phases		3
Power Factor		0,8
No of Bearings		Single
No of Poles		4
No of Leads		6-12
Insulation Class		H
Degree of Protection		IP23
Excitation System		AVR

OPTIONAL GENSET CONTROLLERS

Next generation single gen-set controllers for Stand-by and Prime power applications combining multi-functionality and wide communication with EFI engines.

Datakom SMART 200



Datakom D500



Datakom D500-GSM



EMKO Trans-AUTO



DEEPSEA 7320



ComAp AMF25



	Datakom SMART 200	Datakom D500	Datakom D500-GSM	Deepsea 6120	Deepsea 7320	ComAp AMF25	EMKO Trans-AUTO
Automatic Mains Monitoring	✓	✓	✓	✓	✓	✓	✓
Manuel Start	✓	✓	✓	✓	✓	✓	✓
Remote Start	OPTIONAL	OPTIONAL	✓	X	OPTIONAL	OPTIONAL	OPTIONAL
Remote Monitoring With Sim Card	X	OPTIONAL	OPTIONAL	OPTIONAL	OPTIONAL	OPTIONAL	OPTIONAL
1 Aditlonal Option (Horn, Oil-Fuel Heater Etc.)	✓	✓	✓	✓	✓	✓	✓
Light Warning And Mimic Diagram	✓	✓	✓	✓	✓	✓	✓
Battery Charger	✓	✓	✓	✓	✓	✓	✓
Rs-485 Communication	OPTIONAL	✓	✓	X	✓	OPTIONAL	✓
Ethernet (Tcp-Ip) Communication	X	✓	✓	X	OPTIONAL	OPTIONAL	OPTIONAL

GENSET CONTROLLERS FOR SYNCHRONIZATION SYSTEMS

Next generation synchronizing genset controller capable of every communication and functionality.

Datakom D500 MK2



Datakom D700



DEEPSEA 8610



DEEPSEA 8620



DEEPSEA 8660



ComAp IntelliCompact NT SPTM



ComAp IntelliGen BaseBox



ComAp IntelliGen 200



DIMENSIONS

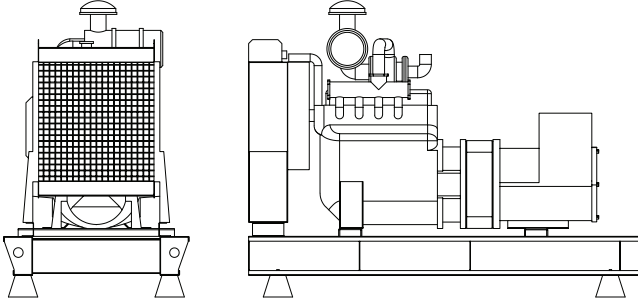

OPEN TYPE

WxLxH	mm	1400 x 3150 x 2035
Weight	kg	3050
Fuel Tank Capacity	lt	846

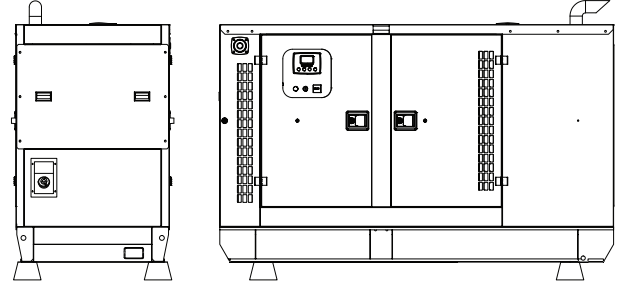

CANOPIED

WxLxH	mm	1400 x 3750 x 2646
Weight	kg	3590
Fuel Tank Capacity	lt	846

SOUND PROF CANOPIED

- Special design for minimizing acoustic level
- Galvanized steel construction further protected by polyester powder coat paint
- Black finish stainless steel locks and hinges
- Control panel viewing window in a lockable access door
- Emergency stop push button (red) mounted on enclosure exterior
- Lifting, drag and jacking points on base frame
- Radiator fill via removable, flush mounted rain cap fitted with compression seal

OPTIONAL EQUIPMENTS

Some of our Optional Equipments which can be provided with Generator Sets But not limited to;

- Medium voltage alternator
- Remote radiator applications
- External fuel tanks. Automatic and Manuel fuel filling system from external fuel tanks
- Fuel tank heater, oil pan heater, Anti-condensation heater
- Alternator with PMG (Permanent Magnet Generator)
- Synchronization systems
- Double Walled Fuel Tanks
- Container type canopy
- Lube oil and fuel drain pumps
- Trailer
- Remote monitoring options on the control panel
- Electronic fuel level indicator